

M5 disc styli / M5 cylindrical styli / inquiry

Disc styli M5

Quantity:

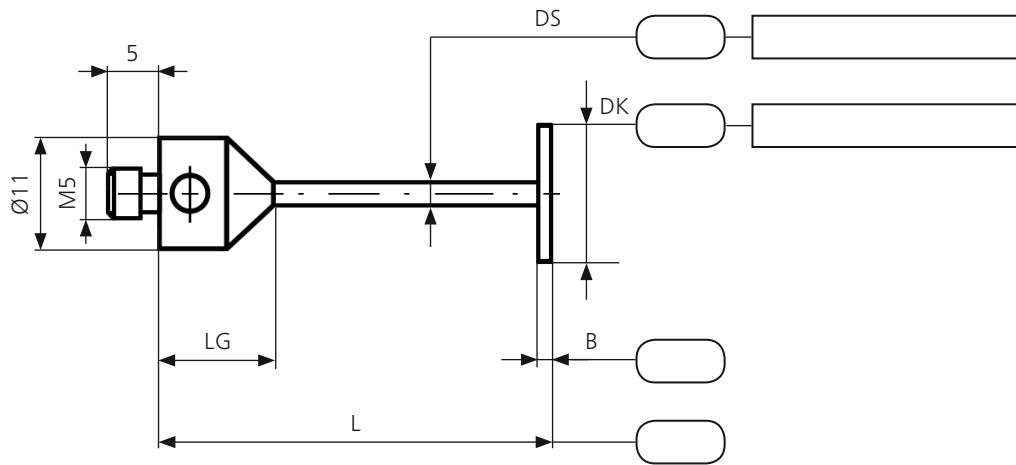

Cylindrical styli M5

Quantity:

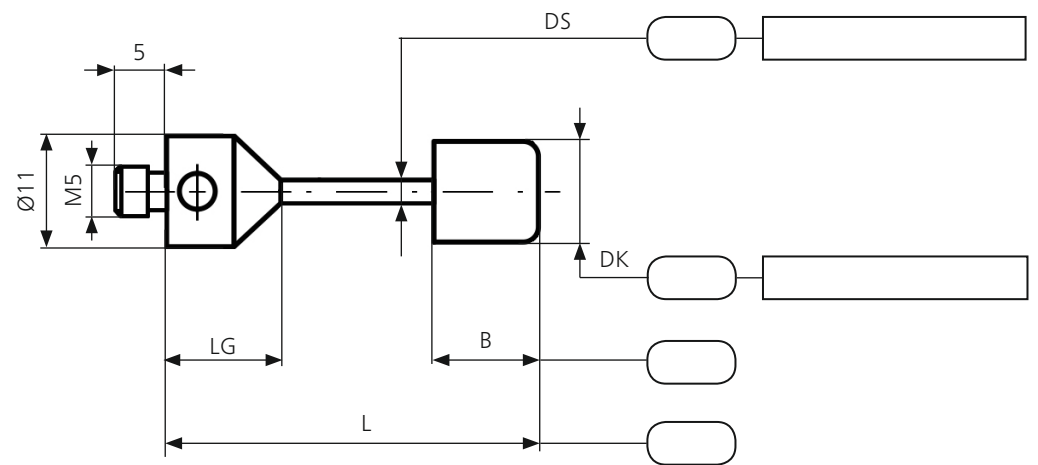

Company

Department

Name, First

Address

City / Zip

Phone

Fax

E-Mail

Fax inquiry:

Please fill in the specifications into the right fields. Mark the desired ball and shaft material. Sign the desired quantity into the fields on the top of the page. Print the page.

Send the fax inquiry to:

+49 7361 6336 29



We make it visible.